

6 1 5 1 4 3 1 2 1 1

D

D

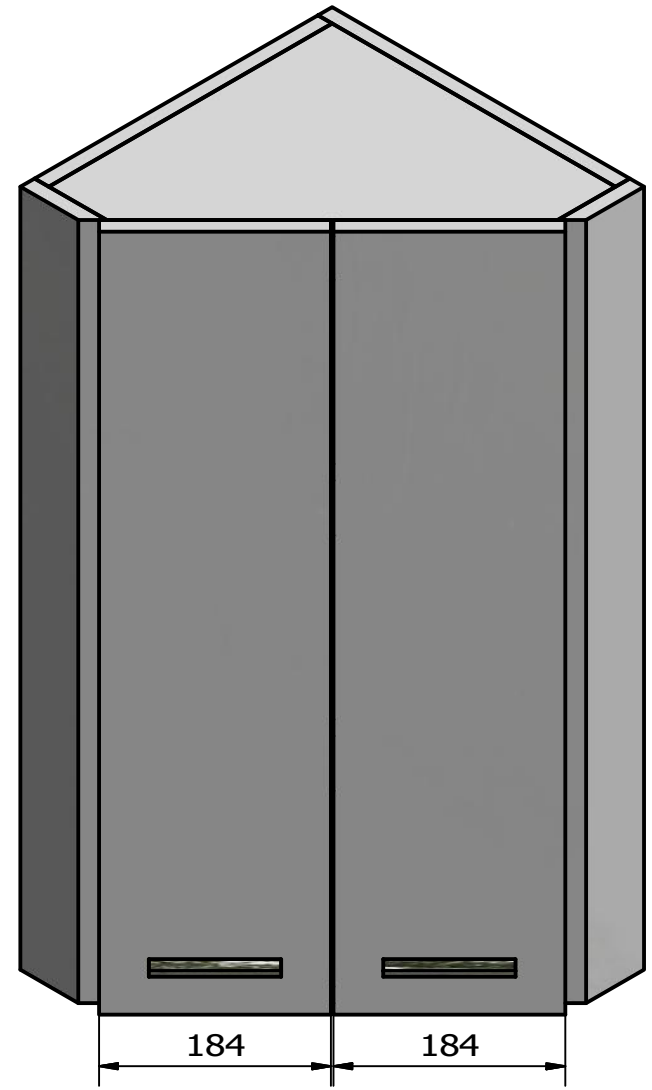
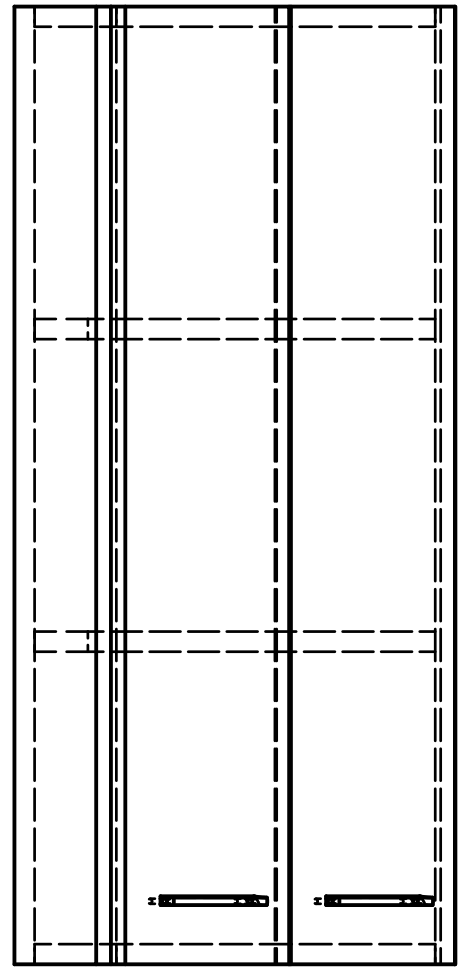
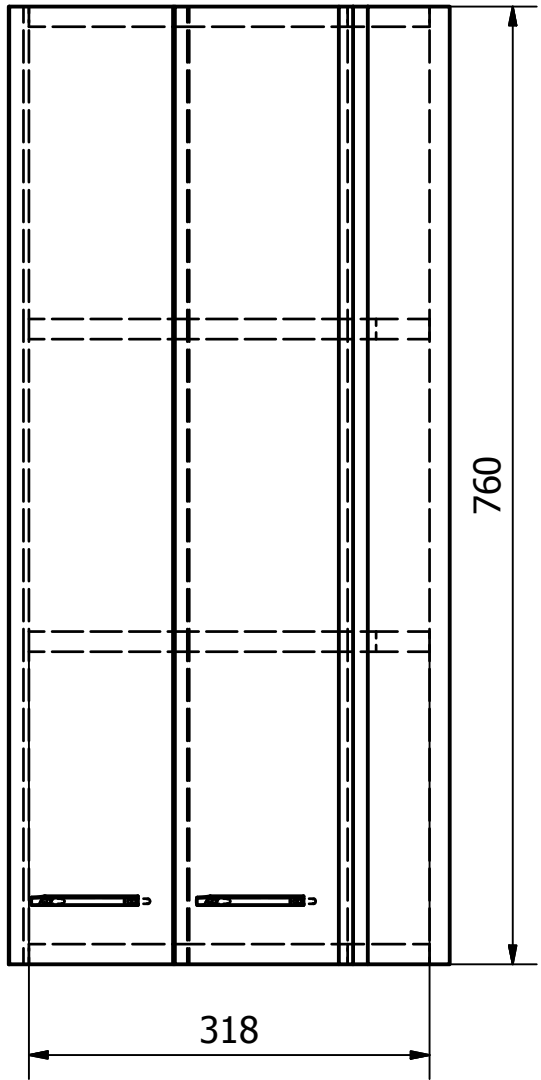

C

C

B

B

A

A

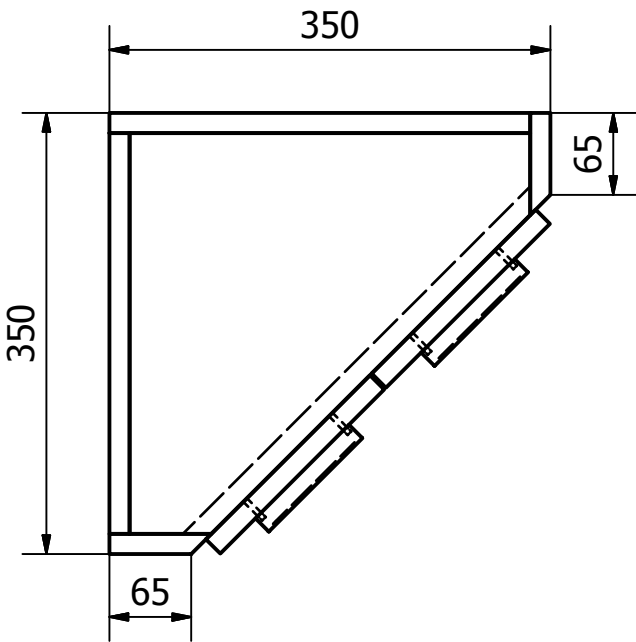

Kreslil	Kontroloval	Schválil - dne	Datum	Datum	
ZOJA/KERAMIA FRESH			50332	Vydání	List
				1	1 / 1

6 1 5 1 4 3 1 2 1 1