

G1/2 - (G3/8) - (Ø 10)

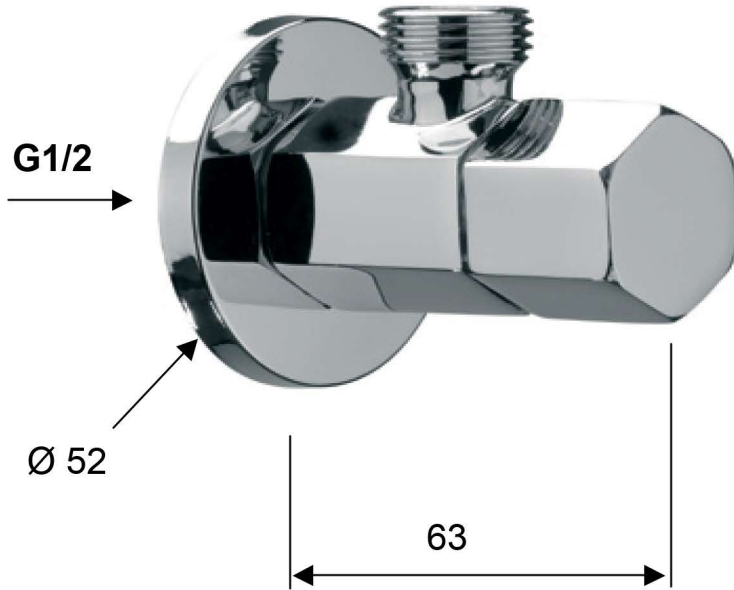

PY58/15