

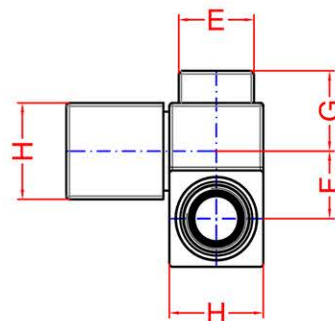

Technické parametry:
 Maximální pracovní tlak: 10 barů
 Maximální pracovní teplota: 100°C

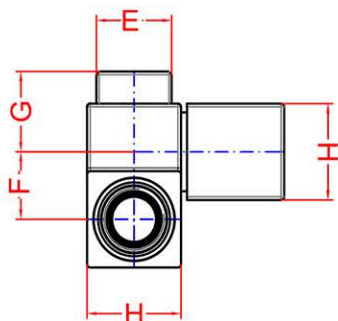

Technical features
 Max working pressure: 10 Bar
 Max temperature: 100°C

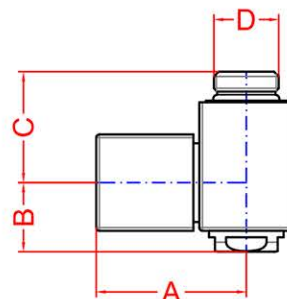
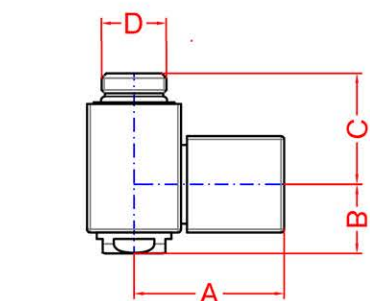

A	B	C	D	E	F	G	H
48	21.5	34.5	1/2"	24-19	21	25	30
48	21.5	34.5	1/2"	24-19	21	25	30

A	B	C	D	E	F	G	H
48	21.5	34.5	1/2"	24-19	21	25	30
48	21.5	34.5	1/2"	24-19	21	25	30

CP562